

Downlight, Flush Lens with Fixed Lamp

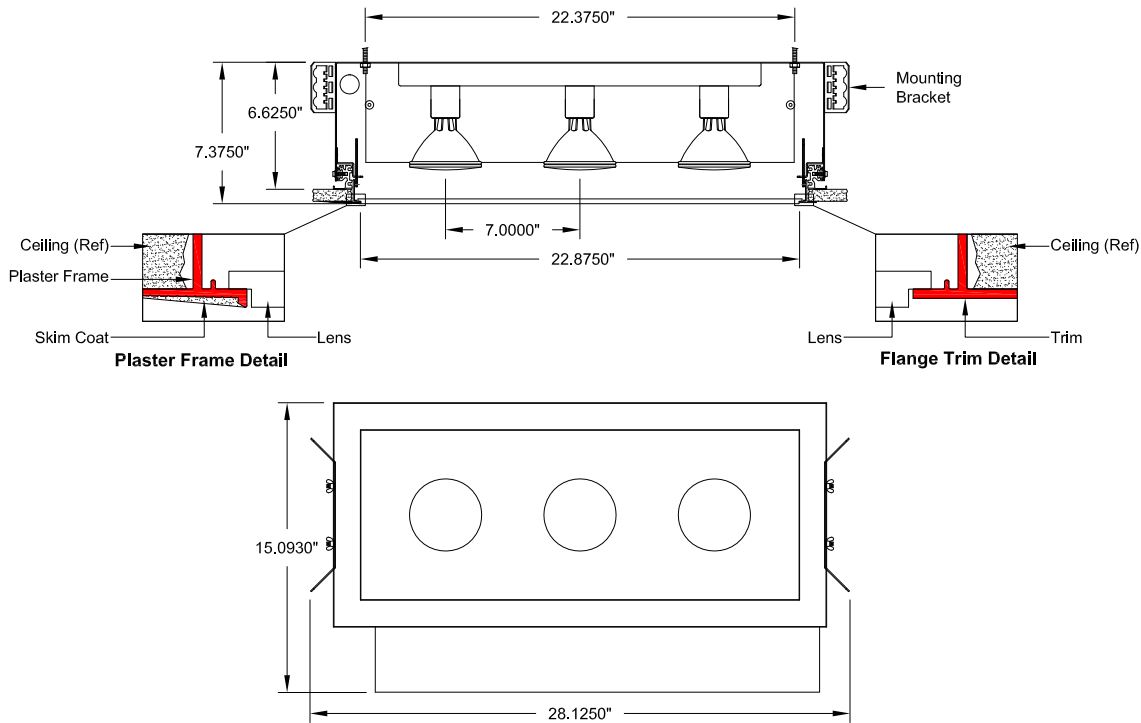

Ceiling Cut-out : 9.7500" x 23.7500"

Trim Flange : 10.6250" x 24.6250"

Aperture: 8.8750" x 22.8750"

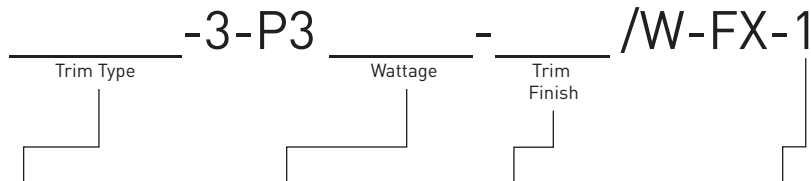

Trim Type	Wattage	Trim Finish	Voltage
<input type="checkbox"/> VLP Plaster	<input type="checkbox"/> 50	<input type="checkbox"/> W White	<input type="checkbox"/> 1 (120V)
<input type="checkbox"/> VLF Flange	<input type="checkbox"/> 75	<input type="checkbox"/> B Black	

Description

Recessed downlight fixture with flush rabbeted lens. Fixed lampholders. Three PAR30 lamps. Flanged or plaster frame trim.

Features

- Standard Lens: Solite
- Below ceiling access to wiring.
- Plaster frame trim provides 0.062" reveal to minimize skim coat cracking.
- Integral Thermal Protection.

Fixture Specifications

Dimensions: 28.125"L x 15.093"W x 6.625"H
 Weight: Approx. 16 lbs.
 Ceiling Cutout: 23.75"L x 9.75"W

Electrical

- Power Consumption: 225 watts max.
- Ambient temperature 100 °F. maximum.
- Through branch wiring capable.

Mounting

Universal mounting brackets included.
 Contact factory for special ceiling conditions.

Options (Consult factory)

- Lenses: Page 2

Photometry: Page 3

Fixture may accommodate R-30 and A-19 Medium Base lamps, consult factory.







All designs and scaled drawings shall remain the property of STARFIRE LIGHTING, INC., and may not be reproduced or transmitted without expressed written consent. STARFIRE LIGHTING, INC. reserves the right to make changes on approved designs to facilitate manufacturing methods to the extent that such changes do not compromise design integrity.

VL-3-P3

Job Name:

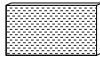
Fixture Type:

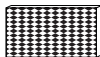
Lens Options

	Lenses		Cat. No.
<input type="checkbox"/>		Solite Spread Lens	S0
<input type="checkbox"/>		Frosted Solite Spread Lens	FS
<input type="checkbox"/>		Prismatic Spread Lens	PR
<input type="checkbox"/>		Frosted Prismatic Spread Lens	FP

For other lens options, consult factory.

VersaLux™ Series VL

Downlight, Flush Lens with Fixed Lamp

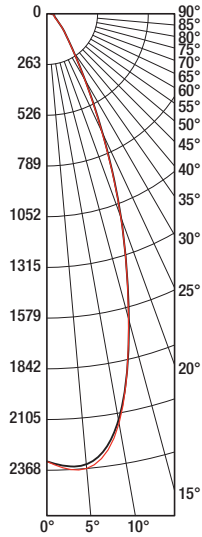

— 0° Plane — 90° Plane

3 Lamp Photometrics

50 Watt PAR30, 40° Flood

Solite Lens

Photometry reports for other fixture configurations, consult factory

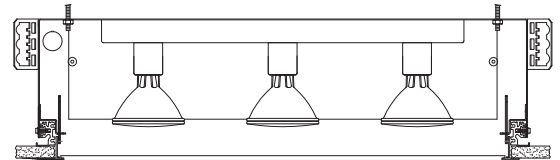

Total Luminaire Efficiency: 89.90%

Candela Distribution

	0	15	30	45	60	75	90
0	2322	2322	2322	2322	2322	2322	2322
5	2345	2353	2353	2367	2365	2365	2368
10	2142	2159	2149	2152	2153	2133	2157
15	1642	1640	1644	1646	1641	1631	1636
20	1125	1134	1131	1123	1119	1121	1121
25	684	689	685	684	680	675	675
30	397	398	396	396	392	393	393
35	246	246	245	243	242	240	241
40	168	168	167	169	165	168	168
45	125	126	125	125	125	125	124
50	94	94	94	94	93	92	93
55	71	71	72	73	71	69	70
60	58	58	57	57	56	54	54
65	49	49	48	48	47	45	45
70	43	44	43	43	42	42	42
75	40	39	39	39	39	39	39
80	39	38	39	38	38	38	38
85	29	30	30	29	29	29	29
90	11	11	11	11	10	11	11

Zonal Lumen Summary

5	113
10	205
15	233
20	211
25	158
30	108
35	77
40	59
45	49
50	39
55	32
60	27
65	24
70	22
75	21
80	21
85	16
90	3

Utilization

RC	80				70				50			30			10			Flux
	70	50	30	10	70	50	30	10	50	30	10	50	30	10	50	30	10	
0	108	108	108	108	105	105	105	105	101	101	101	96	96	96	92	92	92	91
1	101	98	96	93	99	96	94	92	93	91	89	89	88	86	83	83	83	82
2	96	91	86	83	94	89	85	82	86	83	80	83	81	78	76	76	76	75
3	91	84	79	75	89	83	78	75	81	77	73	78	75	72	70	70	70	70
4	86	79	73	69	84	78	73	69	76	71	68	74	70	67	65	65	65	65
5	82	74	68	64	80	73	68	64	71	67	63	70	66	63	61	61	61	61
6	78	70	64	60	77	69	64	60	68	63	59	66	62	59	57	57	57	57
7	75	66	60	56	73	65	60	56	64	59	56	63	59	56	54	54	54	54
8	71	63	57	53	70	62	57	53	61	56	53	60	56	53	51	51	51	51
9	68	60	54	51	67	59	54	51	58	54	50	58	53	50	49	49	49	49
10	66	57	52	48	65	56	51	48	56	51	48	55	51	48	47	47	47	4