

4" VersaLux LED Low Profile Slot

LED



LED Linear Recessed Low Profile Slot
Flush Snap-in Lens

VL4-LO

Job Name _____

Fixture Type _____

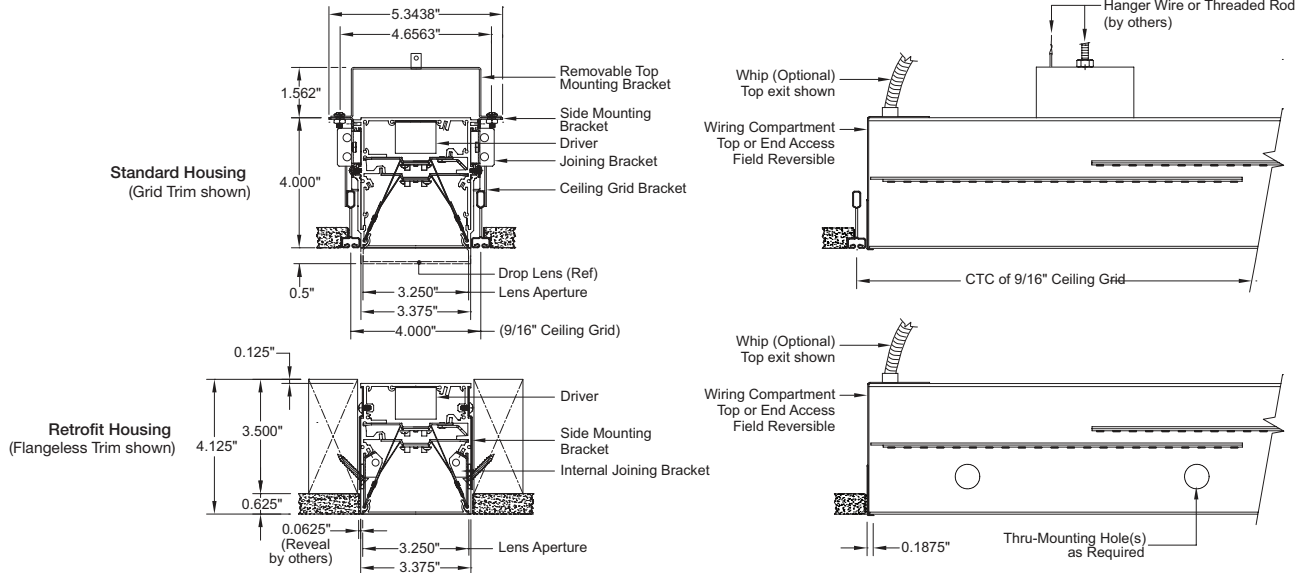

Ceiling Trim Details

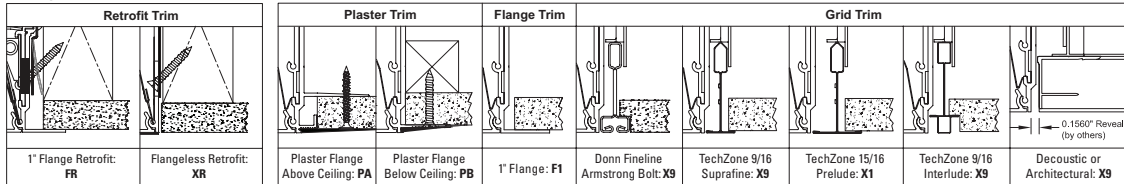

VL4-LO-								-W
CRI	Color	Output	Dimming	Lens	Length(")	Ceiling Trim	Whip	
8 80+	27 2700K	S Standard	S Std. 0-10V 1%	DF Diffuser	<i>Nominal:</i> 24 36 48	PA Plaster Flange Above	N No Whip	
9 90+	30 3000K	H High	H ECO 1%	D1 Drop 1/2"	60 72 84	PB Plaster Flange Below	W Std. Whip	
	35 3500K	M Maximum	D DALI 1%	BW Batwing	96 (see Page 3)	F1 Flange 1"	C Chicago Whip	
	40 4000K	Custom: Specify Lm/Ft ⁽¹⁾	P POE ⁽¹⁾	LW Louver White	Custom: xxx (in inches)	X9 9/16 Grid Trim		
	TW 2700K-6500K		W Wireless ⁽¹⁾	LS Louver Specular		X1 15/16 Grid Trim		
						FR 1" Flange Retrofit		
						XR Flangeless Retrofit		

Product Code Example: VL4-LO-830HSD1-120-X9-WN

*Fixture must be installed before ceiling

Low profile, flush lens slot utilizing high performance LED boards, snap-in lenses and full reflectors. Use in ceilings where low profile is required. Available with plaster, flange or grid trim options for new construction and flange or flangeless trims for retrofit installations.

Features

- Starfire's proprietary EvenGlow™ system provides uniform illumination from end-to-end without lamp imaging, bright spots or shadows at any length
- Fixtures fabricated to any length without custom engineering
- Exceptional lumen per watt efficiency
- High efficiency, low cost, Tunable White option
- High performance snap-in lenses; flush diffusion, flush batwing, or drop with illuminated end caps, plus white or specular louver options

Fixture Specifications

- Housing/Trim: Heavy-duty extruded aluminum
- Finish: White (std), custom available
- Weight: Approx. 3.3 lbs. per linear foot
- UL Listed, (indoor non-condensing) & CCEA Approved

Electrical

- Power consumption: Per specification based on LED configuration
- Input Voltage: 120-277V universal driver
- Ambient operating range: -4 °F to +100 °F
- Integral electronic drivers
- Integral wiring bus between fixture sections
- Drivers with full dimming range at any output choice
- Dimming: 0-10V 1% standard, contact factory for options

Mounting

- Universal mounting brackets provided. Contact factory for alternate mounting
- Easy Access wiring compartment – all connections can be made without disassembling the fixture. 7/8" knockouts provided for top or end.

Ceiling Cutout: Refer to Page 3

Options (Consult factory)

- 6 ft armored whip, may be factory installed
- Occupancy sensor, daylight control module
- EM pack (Delivers 800+ total lumens for 90 mins). Specify length and location (+/- 2ft) at time of order
- HVAC, fire sprinkler, surveillance or public address systems integration

⁽¹⁾ Specify – Factory to confirm



STARFIRE LIGHTING, INC.
7 Donna Drive, Wood-Ridge, NJ 07075
starfirelighting.com

P 201.438.9540
F 201.438.9541

All designs and drawings are the property of STARFIRE LIGHTING, INC. We reserve the right to make changes to specifications and approved designs at any time without notice to facilitate manufacturing methods to the extent that such changes do not compromise design integrity. All performance specifications are subject to +/- 10% deviation.

4" VersaLux LED Low Profile Slot, Flush Snap-in Lens

VL4-LO

Linear Photometrics

LED Strip

High output edge-to-edge, end-to-end illumination

- Choice of lumen output levels:
 - S:** Standard
 - H:** High
 - M:** Maximum
 - C:** Custom (between 300 and 1000 Lm/Ft)
- LED Efficiency: Up to 160 Lm/Wt at Maximum output and 180 Lm/Wt at Standard power (at 80+ CRI)
- L70: 50,000+ hours at Maximum output
- 2700K, 3000K, 3500K, 4000K and Tunable White: 2700K-6500K
- CRI: 80+ or 90+
- Color Consistency: Equal or better than 3 SCDM with chip mixing
- 5 year limited warranty*

Diffuser

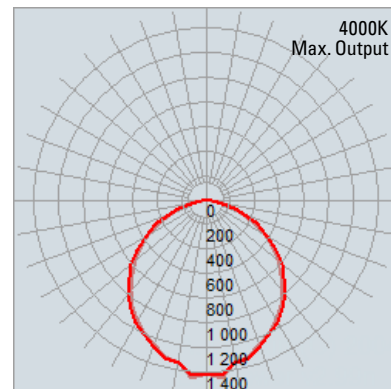

Drop 1/2"

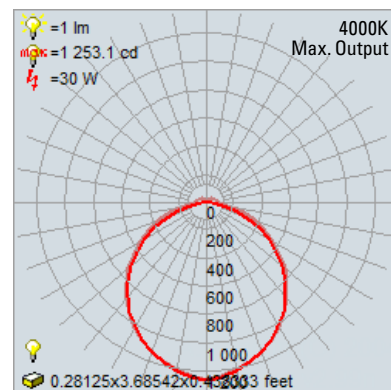

Diffuser

80 CRI		4000K		3500K		3000K		2700K	
Output Setting	Lm/Ft	Wt/Ft	Lm/Wt	Wt/Ft	Lm/Wt	Wt/Ft	Lm/Wt	Wt/Ft	Lm/Wt
S Standard	500	3.89	128	3.97	125.9	4.14	120.8	4.69	106.7
H High	750	6.09	123.1	6.22	120.5	6.5	115.4	7.5	100
M Maximum	1000	8.5	117.7	8.68	115.2	9.09	110.1	10.71	93.3

Performance for nominal 4 foot length or greater (Std. 6ft)

1/2" Drop Lens

80 CRI		4000K		3500K		3000K		2700K	
Output Setting	Lm/Ft	Wt/Ft	Lm/Wt	Wt/Ft	Lm/Wt	Wt/Ft	Lm/Wt	Wt/Ft	Lm/Wt
S Standard	500	3.7	133.6	3.8	130.9	4.0	125.6	4.5	111.2
H High	750	5.8	128.2	6.0	125.6	6.2	120.3	7.2	104.5
M Maximum	1000	8.1	122.9	8.3	120.2	8.7	114.9	10.2	97.8

Performance for nominal 4 foot length or greater (Std. 6ft)

Batwing

80 CRI		4000K		3500K		3000K		2700K	
Output Setting	Lm/Ft	Wt/Ft	Lm/Wt	Wt/Ft	Lm/Wt	Wt/Ft	Lm/Wt	Wt/Ft	Lm/Wt
S Standard	500	4.1	122.2	4.2	119.8	4.4	114.9	4.9	101.3
H High	750	6.4	116.8	6.6	114.4	6.8	109.5	7.9	94.7
M Maximum	1000	9.0	111.5	9.2	109.1	9.6	104.2	11.4	88.0

Performance for nominal 4 foot length or greater (Std. 6ft)

Batwing

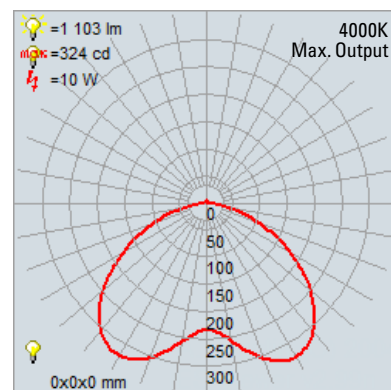

* See Starfire website for Product Limited Warranty



STARFIRE LIGHTING, INC.
7 Donna Drive, Wood-Ridge, NJ 07075
starfirelighting.com

P 201.438.9540
F 201.438.9541

All designs and drawings are the property of STARFIRE LIGHTING, INC. We reserve the right to make changes to specifications and approved designs at any time without notice to facilitate manufacturing methods to the extent that such changes do not compromise design integrity. All performance specifications are subject to +/- 10% deviation.

4" VersaLux LED Low Profile Slot, Flush Snap-in Lens

VL4-LO

Ceiling Dimensions

Grid Ceiling Dimensions

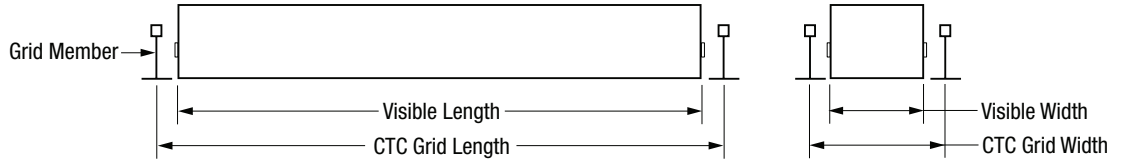

Order CTC Grid Length	9/16", Don Finline, Decoustic			15/16"		
	Visible Length	Visible Width	CTC Grid Width	Visible Length	Visible Width	CTC Grid Width
24"	23 3/8"	3 3/8"	4"	23"	3 3/8"	4 3/8"
30"	29 3/8"	3 3/8"	4"	29"	3 3/8"	4 3/8"
36"	35 3/8"	3 3/8"	4"	35"	3 3/8"	4 3/8"
48"	47 3/8"	3 3/8"	4"	47"	3 3/8"	4 3/8"
60"	59 3/8"	3 3/8"	4"	59"	3 3/8"	4 3/8"
72"	71 3/8"	3 3/8"	4"	71"	3 3/8"	4 3/8"
84"	83 3/8"	3 3/8"	4"	83"	3 3/8"	4 3/8"
90"	89 3/8"	3 3/8"	4"	89"	3 3/8"	4 3/8"
96"	95 3/8"	3 3/8"	4"	95"	3 3/8"	4 3/8"

Custom Fixture Length Example:

A 24" Nominal Order Length yields a 23 3/8" Visible Length.
 For a 24" Visible Length, order a Custom Length of 24 5/8".
 See charts below for length adjustments per trim type.

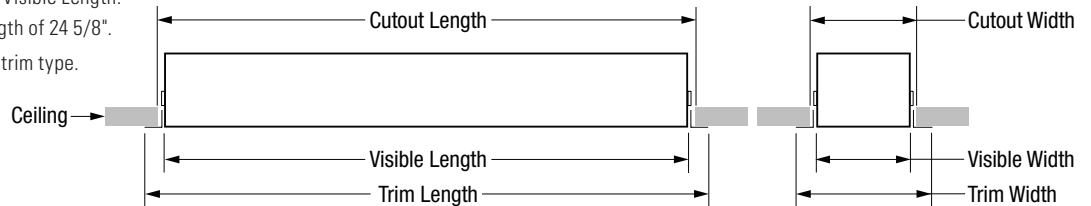

Solid Ceiling Dimensions

Nominal Order Length	Visible Length	Visible Width	Plaster Flange				1" Flange ⁽¹⁾				Retrofit 1" Flange ⁽²⁾			
			Trim Length	Trim Width	Cutout Length	Cutout Width	Trim Length	Trim Width	Cutout Length	Cutout Width	Trim Length	Trim Width	Cutout Length	Cutout Width
24"	23 3/8"	3 3/8"	26 3/32"	6 3/32"	24 1/4"	4 1/4"	25 1/8"	5 1/8"	24 1/4"	4 1/4"	25 1/8"	5 1/8"	24 1/4"	4 1/4"
30"	29 3/8"	3 3/8"	32 3/32"	6 3/32"	30 1/4"	4 1/4"	31 1/8"	5 1/8"	30 1/4"	4 1/4"	31 1/8"	5 1/8"	30 1/4"	4 1/4"
36"	35 3/8"	3 3/8"	38 3/32"	6 3/32"	36 1/4"	4 1/4"	37 1/8"	5 1/8"	36 1/4"	4 1/4"	37 1/8"	5 1/8"	36 1/4"	4 1/4"
48"	47 3/8"	3 3/8"	50 3/32"	6 3/32"	48 1/4"	4 1/4"	49 1/8"	5 1/8"	48 1/4"	4 1/4"	49 1/8"	5 1/8"	48 1/4"	4 1/4"
60"	59 3/8"	3 3/8"	62 3/32"	6 3/32"	60 1/4"	4 1/4"	61 1/8"	5 1/8"	60 1/4"	4 1/4"	61 1/8"	5 1/8"	60 1/4"	4 1/4"
72"	71 3/8"	3 3/8"	74 3/32"	6 3/32"	72 1/4"	4 1/4"	73 1/8"	5 1/8"	72 1/4"	4 1/4"	73 1/8"	5 1/8"	72 1/4"	4 1/4"
84"	83 3/8"	3 3/8"	86 3/32"	6 3/32"	84 1/4"	4 1/4"	85 1/8"	5 1/8"	84 1/4"	4 1/4"	85 1/8"	5 1/8"	84 1/4"	4 1/4"
90"	89 3/8"	3 3/8"	92 3/32"	6 3/32"	90 1/4"	4 1/4"	91 1/8"	5 1/8"	90 1/4"	4 1/4"	91 1/8"	5 1/8"	90 1/4"	4 1/4"
96"	95 3/8"	3 3/8"	98 3/32"	6 3/32"	96 1/4"	4 1/4"	97 1/8"	5 1/8"	96 1/4"	4 1/4"	97 1/8"	5 1/8"	96 1/4"	4 1/4"
Custom Order Length	Order Length - 5/8"	3 3/8"	Order Length + 2 3/32"	6 3/32"	Order Length + 1/4"	4 1/4"	Order Length + 1 1/8"	5 1/8"	Order Length + 1/4"	4 1/4"	Order Length + 1 1/8"	5 1/8"	Order Length + 1/4"	4 1/4"

Nominal Order Length	Visible Length	Visible Width	Grid Trim ⁽³⁾				Retrofit Flangeless			
			Trim Length	Trim Width	Cutout Length	Cutout Width	Trim Length	Trim Width	Cutout Length	Cutout Width
24"	23 3/8"	3 3/8"	23 3/8"	4 3/16"	23 1/2"	3 1/2"	25 1/8"	3 3/8"	23 1/2"	3 1/2"
30"	29 3/8"	3 3/8"	29 3/8"	4 3/16"	29 1/2"	3 1/2"	31 1/8"	3 3/8"	29 1/2"	3 1/2"
36"	35 3/8"	3 3/8"	35 3/8"	4 3/16"	35 1/2"	3 1/2"	37 1/8"	3 3/8"	35 1/2"	3 1/2"
48"	47 3/8"	3 3/8"	47 3/8"	4 3/16"	47 1/2"	3 1/2"	49 1/8"	3 3/8"	47 1/2"	3 1/2"
60"	59 3/8"	3 3/8"	59 3/8"	4 3/16"	59 1/2"	3 1/2"	61 1/8"	3 3/8"	59 1/2"	3 1/2"
72"	71 3/8"	3 3/8"	71 3/8"	4 3/16"	71 1/2"	3 1/2"	73 1/8"	3 3/8"	72 1/4"	3 1/2"
84"	83 3/8"	3 3/8"	83 3/8"	4 3/16"	83 1/2"	3 1/2"	85 1/8"	3 3/8"	84 1/4"	3 1/2"
90"	89 3/8"	3 3/8"	89 3/8"	4 3/16"	89 1/2"	3 1/2"	91 1/8"	3 3/8"	90 1/4"	3 1/2"
96"	95 3/8"	3 3/8"	95 3/8"	4 3/16"	95 1/2"	3 1/2"	97 1/8"	3 3/8"	96 1/4"	3 1/2"
Custom Order Length	Order Length - 5/8"	3 3/8"	Order Length - 5/8"	4 3/16"	Order Length - 1/2"	3 1/2"	Order Length - 5/8"	3 3/8"	Order Length - 1/2"	3 1/2"

For lengths over 96", consult factory regarding cutout dimensions.

⁽¹⁾ Fixture must be installed before ceiling.

⁽²⁾ Fixture may be installed after ceiling.

⁽³⁾ Grid Trim typically installed before ceiling or from above solid ceiling.



STARFIRE LIGHTING, INC.
 7 Donna Drive, Wood-Ridge, NJ 07075
 starfirelighting.com

P 201.438.9540
 F 201.438.9541

All designs and drawings are the property of STARFIRE LIGHTING, INC. We reserve the right to make changes to specifications and approved designs at any time without notice to facilitate manufacturing methods to the extent that such changes do not compromise design integrity. All performance specifications are subject to +/- 10% deviation.