

# 2" VersaLux LED Ultra-Low Profile Slot with External Driver

LED



LED Linear Recessed Ultra-Low Profile Slot Flush Snap-in Lens, External Driver

V LX2

Job Name \_\_\_\_\_

Fixture Type \_\_\_\_\_

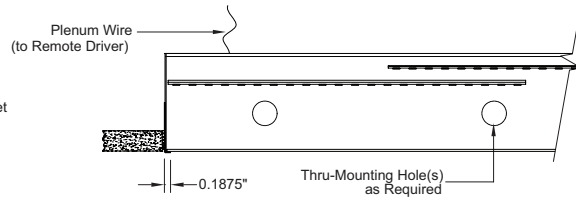
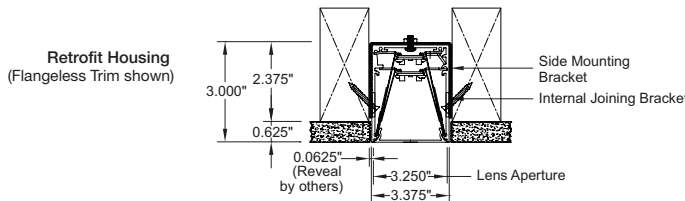
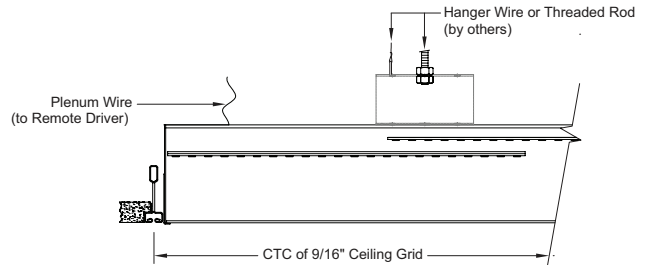
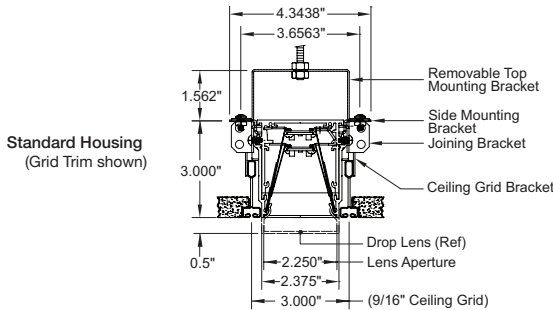

**Ceiling Trim Details**

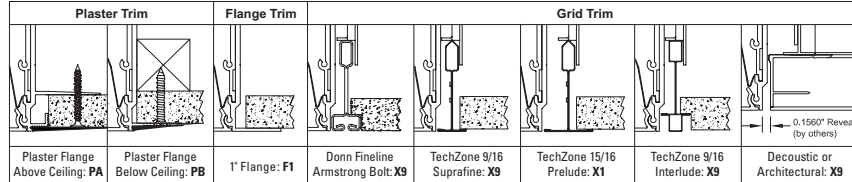
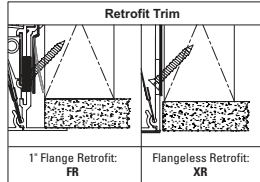

**Remote Driver Enclosure**

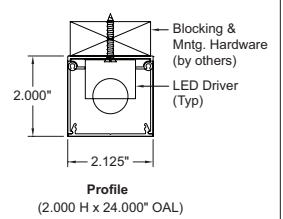

| CRI   | Color          | Output                                  | Dimming                   | Lens               | Length(")                  | Ceiling Trim            |
|-------|----------------|---|---------------------------|--------------------|----------------------------|-------------------------|
| 8 80+ | 27 2700K       | S Standard                              | S Std. 0-10V 1%           | DF Diffuser        | Nominal:<br>24 36 48       | PA Plaster Flange Above |
| 9 90+ | 30 3000K       | H High                                  | H ECO 1%                  | D1 Drop 1/2"       | 60 72 84                   | PB Plaster Flange Below |
|       | 35 3500K       | M Maximum                               | D DALI 1%                 | D2 Drop 2"         | 96 (see Page 3)            | F1 Flange 1"*           |
|       | 40 4000K       | Custom:<br>Specify Lm/Ft <sup>(1)</sup> | P POE <sup>(1)</sup>      | BW Batwing         | Custom:<br>xxx (in inches) | X9 9/16 Grid Trim       |
|       | TW 2700K-6500K |   | W Wireless <sup>(1)</sup> | LW Louver White    |                            | X1 15/16 Grid Trim      |
|       |                |   |                           | LS Louver Specular |                            | FR 1" Flange Retrofit   |
|       |                |   |                           |                    |                            | XR Flangeless Retrofit  |

Product Code Example: VLX2-830HSD1-120-X9-W

Ultra-Low profile, flush lens slot utilizing high performance LED boards, snap-in lenses and full reflectors with an external driver. Use in ceilings where and extra low profile is required. Available with plaster, flange or grid trim options for new construction and flange or flangeless trims for retrofit installations.

**Features**

- Starfire's proprietary EvenGlow™ system provides uniform illumination from end-to-end without lamp imaging, bright spots or shadows at any length
- Fixtures fabricated to any length without custom engineering
- Exceptional lumen per watt efficiency
- High efficiency, low cost, Tunable White option
- High performance snap-in lenses; flush diffusion, flush batwing, or drop with illuminated end caps, plus white or specular louver options

**Fixture Specifications**

- Housing/Trim: Heavy-duty extruded aluminum
- Finish: White (std), custom available
- Weight: Approx. 3.2 lbs. per linear foot
- UL Listed, (indoor non-condensing)

**Electrical**

- Power consumption: Per specification based on LED configuration
- Input Voltage: 120-277V universal driver
- Ambient operating range: -4 °F to +100 °F
- Remote electronic drivers
- Class 2 plenum wiring between fixture and remote driver
- Drivers with full dimming range at any output choice
- Dimming: 0-10V 1% standard, contact factory for options

**Mounting**

- Universal mounting brackets provided. Contact factory for alternate mounting
- Driver enclosure will support one fixture. Contact factory for other configurations

**Ceiling Cutout:** Refer to Page 3

**Options (Consult factory)**

- Occupancy sensor, daylight control module
- EM pack (Delivers 800+ total lumens for 90 mins). Specify length and location (+/- 2ft) at time of order
- HVAC, fire sprinkler, surveillance or public address systems integration

\*Fixture must be installed before ceiling

<sup>(1)</sup> Specify – Factory to confirm



STARFIRE LIGHTING, INC.  
7 Donna Drive, Wood-Ridge, NJ 07075  
starfirelighting.com

P 201.438.9540  
F 201.438.9541

All designs and drawings are the property of STARFIRE LIGHTING, INC. We reserve the right to make changes to specifications and approved designs at any time without notice to facilitate manufacturing methods to the extent that such changes do not compromise design integrity. All performance specifications are subject to +/- 10% deviation.

# 2" VersaLux LED Ultra-Low Profile Slot with Flush Snap-in Lens and External Driver

## VLX2

## Linear Photometrics

### LED Strip

High output edge-to-edge, end-to-end illumination

- Choice of lumen output levels:
  - S:** Standard
  - H:** High
  - M:** Maximum
  - C:** Custom (between 400 and 1000 Lm/Ft)
- LED Efficiency: Up to 160 Lm/Wt at Maximum output and 180 Lm/Wt at Standard power (at 80+ CRI)
- L70: 50,000+ hours at Maximum output
- Color Consistency: Equal or better than 3 SCDM with chip mixing
- 5 year limited warranty\*

### Diffuser

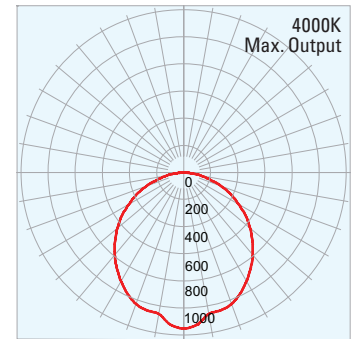

### 1/2" Drop

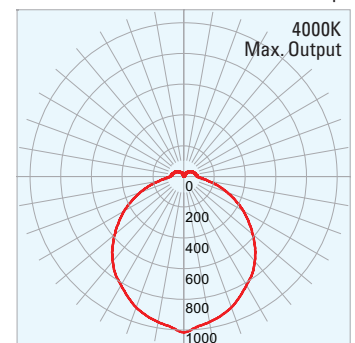

### Diffuser

| 80 CRI            |            | 4000K |       | 3500K |       | 3000K |       | 2700K |       |
|-------------------|------------|-------|-------|-------|-------|-------|-------|-------|-------|
| Output Setting    | Lm/Ft      | Wt/Ft | Lm/Wt | Wt/Ft | Lm/Wt | Wt/Ft | Lm/Wt | Wt/Ft | Lm/Wt |
| <b>S</b> Standard | <b>400</b> | 3.4   | 119.0 | 3.4   | 116.7 | 3.6   | 112.0 | 4.0   | 99.4  |
| <b>H</b> High     | <b>700</b> | 6.2   | 112.6 | 6.3   | 110.2 | 6.6   | 105.6 | 7.7   | 91.4  |
| <b>M</b> Maximum  | <b>850</b> | 7.8   | 109.4 | 7.9   | 107.0 | 8.3   | 102.3 | 9.7   | 87.4  |

Performance for nominal 4 foot length or greater (Std. 6ft)

### 2" Drop

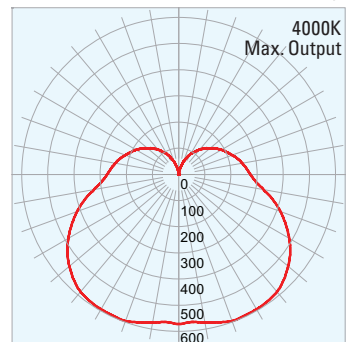

### 1/2" Drop Lens

| 80 CRI            |            | 4000K |       | 3500K |       | 3000K |       | 2700K |       |
|-------------------|------------|-------|-------|-------|-------|-------|-------|-------|-------|
| Output Setting    | Lm/Ft      | Wt/Ft | Lm/Wt | Wt/Ft | Lm/Wt | Wt/Ft | Lm/Wt | Wt/Ft | Lm/Wt |
| <b>S</b> Standard | <b>400</b> | 3.3   | 122.0 | 3.3   | 119.6 | 3.5   | 114.8 | 3.9   | 102.0 |
| <b>H</b> High     | <b>700</b> | 6.1   | 115.6 | 6.2   | 113.2 | 6.5   | 108.4 | 7.4   | 94.0  |
| <b>M</b> Maximum  | <b>850</b> | 7.6   | 112.4 | 7.7   | 110.0 | 8.1   | 105.2 | 9.4   | 90.0  |

Performance for nominal 4 foot length or greater (Std. 6ft)

### 2" Drop Lens

| 80 CRI            |            | 4000K |       | 3500K |       | 3000K |       | 2700K |       |
|-------------------|------------|-------|-------|-------|-------|-------|-------|-------|-------|
| Output Setting    | Lm/Ft      | Wt/Ft | Lm/Wt | Wt/Ft | Lm/Wt | Wt/Ft | Lm/Wt | Wt/Ft | Lm/Wt |
| <b>S</b> Standard | <b>400</b> | 2.7   | 147.3 | 2.8   | 144.4 | 2.9   | 138.7 | 3.2   | 123.8 |
| <b>H</b> High     | <b>700</b> | 5.0   | 140.8 | 5.1   | 138.0 | 5.3   | 132.3 | 6.0   | 115.8 |
| <b>M</b> Maximum  | <b>850</b> | 6.2   | 137.6 | 6.3   | 134.8 | 6.6   | 129.0 | 7.6   | 111.8 |

Performance for nominal 4 foot length or greater (Std. 6ft)

### Batwing

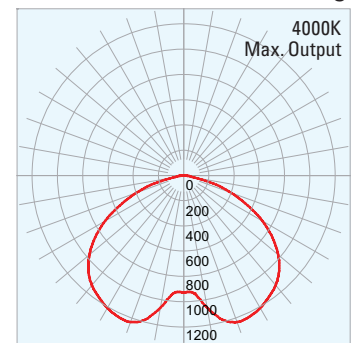

### Batwing

| 80 CRI            |            | 4000K |       | 3500K |       | 3000K |       | 2700K |       |
|-------------------|------------|-------|-------|-------|-------|-------|-------|-------|-------|
| Output Setting    | Lm/Ft      | Wt/Ft | Lm/Wt | Wt/Ft | Lm/Wt | Wt/Ft | Lm/Wt | Wt/Ft | Lm/Wt |
| <b>S</b> Standard | <b>400</b> | 3.1   | 131.1 | 3.1   | 128.5 | 3.2   | 123.4 | 3.6   | 109.8 |
| <b>H</b> High     | <b>700</b> | 5.6   | 124.7 | 5.7   | 122.1 | 6.0   | 117.0 | 6.9   | 101.8 |
| <b>M</b> Maximum  | <b>850</b> | 7.0   | 121.5 | 7.1   | 118.9 | 7.5   | 113.8 | 8.7   | 97.8  |

Performance for nominal 4 foot length or greater (Std. 6ft)

\* See Starfire website for Product Limited Warranty



STARFIRE LIGHTING, INC.  
7 Donna Drive, Wood-Ridge, NJ 07075  
starfirelighting.com

P 201.438.9540  
F 201.438.9541

All designs and drawings are the property of STARFIRE LIGHTING, INC. We reserve the right to make changes to specifications and approved designs at any time without notice to facilitate manufacturing methods to the extent that such changes do not compromise design integrity. All performance specifications are subject to +/- 10% deviation.

# 2" VersaLux LED Ultra-Low Profile Slot with Flush Snap-in Lens and External Driver

**VLX2**

## Ceiling Dimensions

### Grid Ceiling Dimensions

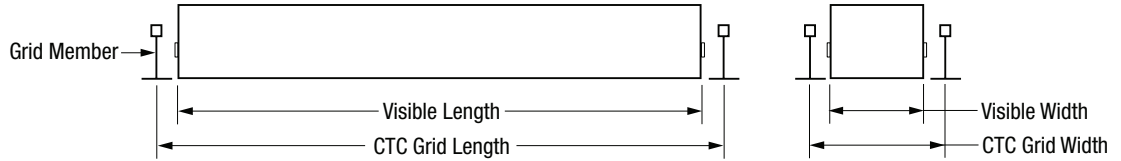

| Order CTC Grid Length | 9/16", Don Fineline, Decoustic |               |                | 15/16"         |               |                |
|-----------------------|--------------------------------|---------------|----------------|----------------|---------------|----------------|
|                       | Visible Length                 | Visible Width | CTC Grid Width | Visible Length | Visible Width | CTC Grid Width |
| 24"                   | 23 3/8"                        | 2 3/8"        | 3"             | 23"            | 2 3/8"        | 3 3/8"         |
| 30"                   | 29 3/8"                        | 2 3/8"        | 3"             | 29"            | 2 3/8"        | 3 3/8"         |
| 36"                   | 35 3/8"                        | 2 3/8"        | 3"             | 35"            | 2 3/8"        | 3 3/8"         |
| 48"                   | 47 3/8"                        | 2 3/8"        | 3"             | 47"            | 2 3/8"        | 3 3/8"         |
| 60"                   | 59 3/8"                        | 2 3/8"        | 3"             | 59"            | 2 3/8"        | 3 3/8"         |
| 72"                   | 71 3/8"                        | 2 3/8"        | 3"             | 71"            | 2 3/8"        | 3 3/8"         |
| 84"                   | 83 3/8"                        | 2 3/8"        | 3"             | 83"            | 2 3/8"        | 3 3/8"         |
| 90"                   | 89 3/8"                        | 2 3/8"        | 3"             | 89"            | 2 3/8"        | 3 3/8"         |
| 96"                   | 95 3/8"                        | 2 3/8"        | 3"             | 95"            | 2 3/8"        | 3 3/8"         |

### Custom Fixture Length Example:

A 24" Nominal Order Length yields a 23 3/8" Visible Length.  
 For a 24" Visible Length, order a Custom Length of 24 5/8".  
 See charts below for length adjustments per trim type.

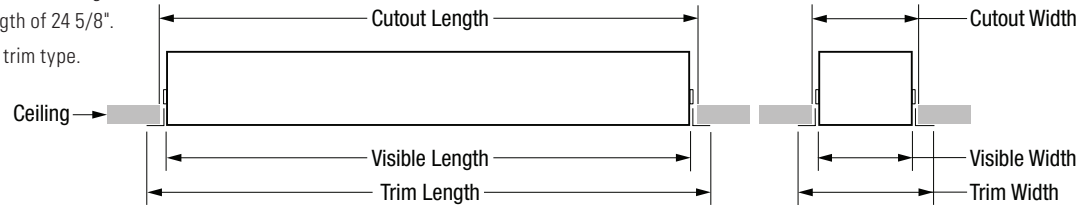

### Solid Ceiling Dimensions

| Nominal Order Length | Visible Length      | Visible Width | Plaster Flange         |            |                     |              | 1" Flange <sup>(1)</sup> |            |                     |              | Retrofit 1" Flange <sup>(2)</sup> |            |                     |              |
|----------------------|---------------------|---------------|------------------------|------------|---------------------|--------------|--------------------------|------------|---------------------|--------------|-----------------------------------|------------|---------------------|--------------|
|                      |                     |               | Trim Length            | Trim Width | Cutout Length       | Cutout Width | Trim Length              | Trim Width | Cutout Length       | Cutout Width | Trim Length                       | Trim Width | Cutout Length       | Cutout Width |
| 24"                  | 23 3/8"             | 2 3/8"        | 26 3/32"               | 5 3/32"    | 24 1/4"             | 3 1/4"       | 25 1/8"                  | 4 1/8"     | 24 1/4"             | 3 1/4"       | 25 1/8"                           | 4 1/8"     | 24 1/4"             | 3 1/4"       |
| 30"                  | 29 3/8"             | 2 3/8"        | 32 3/32"               | 5 3/32"    | 30 1/4"             | 3 1/4"       | 31 1/8"                  | 4 1/8"     | 30 1/4"             | 3 1/4"       | 31 1/8"                           | 4 1/8"     | 30 1/4"             | 3 1/4"       |
| 36"                  | 35 3/8"             | 2 3/8"        | 38 3/32"               | 5 3/32"    | 36 1/4"             | 3 1/4"       | 37 1/8"                  | 4 1/8"     | 36 1/4"             | 3 1/4"       | 37 1/8"                           | 4 1/8"     | 36 1/4"             | 3 1/4"       |
| 48"                  | 47 3/8"             | 2 3/8"        | 50 3/32"               | 5 3/32"    | 48 1/4"             | 3 1/4"       | 49 1/8"                  | 4 1/8"     | 48 1/4"             | 3 1/4"       | 49 1/8"                           | 4 1/8"     | 48 1/4"             | 3 1/4"       |
| 60"                  | 59 3/8"             | 2 3/8"        | 62 3/32"               | 5 3/32"    | 60 1/4"             | 3 1/4"       | 61 1/8"                  | 4 1/8"     | 60 1/4"             | 3 1/4"       | 61 1/8"                           | 4 1/8"     | 60 1/4"             | 3 1/4"       |
| 72"                  | 71 3/8"             | 2 3/8"        | 74 3/32"               | 5 3/32"    | 72 1/4"             | 3 1/4"       | 73 1/8"                  | 4 1/8"     | 72 1/4"             | 3 1/4"       | 73 1/8"                           | 4 1/8"     | 72 1/4"             | 3 1/4"       |
| 84"                  | 83 3/8"             | 2 3/8"        | 86 3/32"               | 5 3/32"    | 84 1/4"             | 3 1/4"       | 85 1/8"                  | 4 1/8"     | 84 1/4"             | 3 1/4"       | 85 1/8"                           | 4 1/8"     | 84 1/4"             | 3 1/4"       |
| 90"                  | 89 3/8"             | 2 3/8"        | 92 3/32"               | 5 3/32"    | 90 1/4"             | 3 1/4"       | 91 1/8"                  | 4 1/8"     | 90 1/4"             | 3 1/4"       | 91 1/8"                           | 4 1/8"     | 90 1/4"             | 3 1/4"       |
| 96"                  | 95 3/8"             | 2 3/8"        | 98 3/32"               | 5 3/32"    | 96 1/4"             | 3 1/4"       | 97 1/8"                  | 4 1/8"     | 96 1/4"             | 3 1/4"       | 97 1/8"                           | 4 1/8"     | 96 1/4"             | 3 1/4"       |
| Custom Order Length  | Order Length - 5/8" | 2 3/8"        | Order Length + 2 3/32" | 5 3/32"    | Order Length + 1/4" | 3 1/4"       | Order Length + 1 1/8"    | 4 1/8"     | Order Length + 1/4" | 3 1/4"       | Order Length + 1 1/8"             | 4 1/8"     | Order Length + 1/4" | 3 1/4"       |

| Nominal Order Length | Visible Length      | Visible Width | Grid Trim <sup>(3)</sup> |            |                     |              | Retrofit Flangeless |            |                     |              |
|----------------------|---------------------|---------------|--------------------------|------------|---------------------|--------------|---------------------|------------|---------------------|--------------|
|                      |                     |               | Trim Length              | Trim Width | Cutout Length       | Cutout Width | Trim Length         | Trim Width | Cutout Length       | Cutout Width |
| 24"                  | 23 3/8"             | 2 3/8"        | 23 3/8"                  | 3 3/16"    | 23 1/2"             | 2 1/2"       | 23 3/8"             | 2 3/8"     | 23 1/2"             | 2 1/2"       |
| 30"                  | 29 3/8"             | 2 3/8"        | 29 3/8"                  | 3 3/16"    | 29 1/2"             | 2 1/2"       | 29 3/8"             | 2 3/8"     | 29 1/2"             | 2 1/2"       |
| 36"                  | 35 3/8"             | 2 3/8"        | 35 3/8"                  | 3 3/16"    | 35 1/2"             | 2 1/2"       | 35 3/8"             | 2 3/8"     | 35 1/2"             | 2 1/2"       |
| 48"                  | 47 3/8"             | 2 3/8"        | 47 3/8"                  | 3 3/16"    | 47 1/2"             | 2 1/2"       | 47 3/8"             | 2 3/8"     | 47 1/2"             | 2 1/2"       |
| 60"                  | 59 3/8"             | 2 3/8"        | 59 3/8"                  | 3 3/16"    | 59 1/2"             | 2 1/2"       | 59 3/8"             | 2 3/8"     | 59 1/2"             | 2 1/2"       |
| 72"                  | 71 3/8"             | 2 3/8"        | 71 3/8"                  | 3 3/16"    | 71 1/2"             | 2 1/2"       | 71 3/8"             | 2 3/8"     | 71 1/2"             | 2 1/2"       |
| 84"                  | 83 3/8"             | 2 3/8"        | 83 3/8"                  | 3 3/16"    | 83 1/2"             | 2 1/2"       | 83 3/8"             | 2 3/8"     | 83 1/2"             | 2 1/2"       |
| 90"                  | 89 3/8"             | 2 3/8"        | 89 3/8"                  | 3 3/16"    | 89 1/2"             | 2 1/2"       | 89 3/8"             | 2 3/8"     | 89 1/2"             | 2 1/2"       |
| 96"                  | 95 3/8"             | 2 3/8"        | 95 3/8"                  | 3 3/16"    | 95 1/2"             | 2 1/2"       | 95 3/8"             | 2 3/8"     | 95 1/2"             | 2 1/2"       |
| Custom Order Length  | Order Length - 5/8" | 2 3/8"        | Order Length - 5/8"      | 3 3/16"    | Order Length - 1/2" | 2 1/2"       | Order Length - 5/8" | 2 3/8"     | Order Length - 1/2" | 2 1/2"       |

For lengths over 96", consult factory regarding cutout dimensions.

<sup>(1)</sup> Fixture must be installed before ceiling.

<sup>(2)</sup> Fixture may be installed after ceiling.

<sup>(3)</sup> Grid Trim typically installed before ceiling or from above solid ceiling.



STARFIRE LIGHTING, INC.  
 7 Donna Drive, Wood-Ridge, NJ 07075  
 starfirelighting.com

P 201.438.9540  
 F 201.438.9541

All designs and drawings are the property of STARFIRE LIGHTING, INC. We reserve the right to make changes to specifications and approved designs at any time without notice to facilitate manufacturing methods to the extent that such changes do not compromise design integrity. All performance specifications are subject to +/- 10% deviation.