

Wallwash, Square Trim with Lens

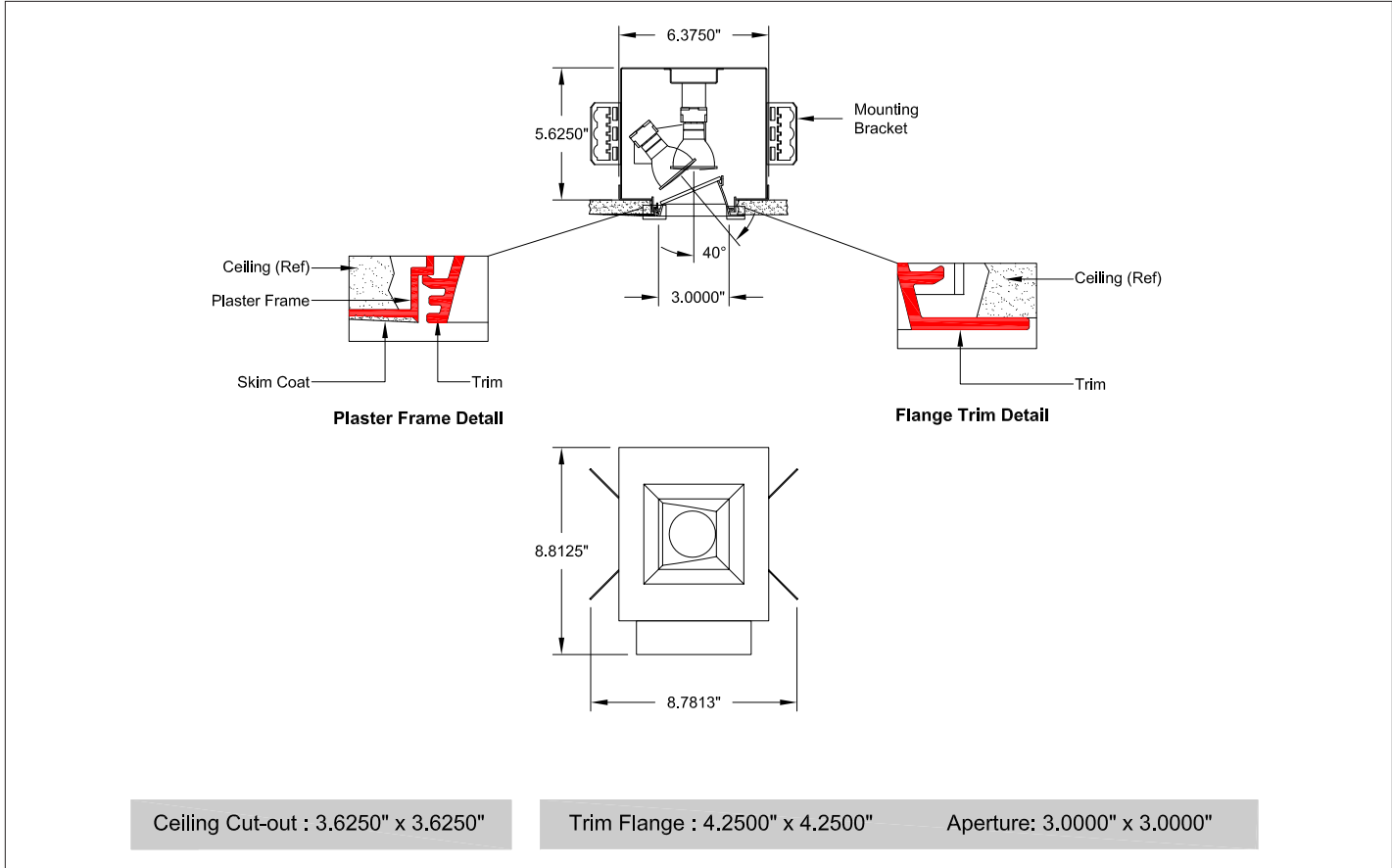

MR16 MH



Ceiling Cut-out : 3.6250" x 3.6250"

Trim Flange : 4.2500" x 4.2500"

Aperture: 3.0000" x 3.0000"

_____ -1-M6M _____ /B _____
 Trim Type Wattage Trim Finish Lampholder Voltage

Trim Type	Wattage	Trim Finish	Lampholder	Voltage
<input type="checkbox"/> VWP-3S Plaster	<input type="checkbox"/> 20	<input type="checkbox"/> W White	<input type="checkbox"/> FX Fixed	<input type="checkbox"/> 1 (120V)
<input type="checkbox"/> VWF-3S Flange	<input type="checkbox"/> 39	<input type="checkbox"/> B Black	<input type="checkbox"/> AD Adjustable	<input type="checkbox"/> 2 (277V)

Description
Recessed metal halide 3" square wallwash fixture with lens. Fixed or adjustable lampholder. One MR16 lamp. Flanged or plaster frame trim.

Features

- Standard Lens: Skytex
- Below ceiling access to the ballast and wiring.
- Lampholder is adjustable from 0°-40°.
- Plaster frame trim provides 0.062" reveal to minimize skim coat cracking.
- Integral Thermal Protection.

Fixture Specifications
Dimensions: 8.812"L x 8.781"W x 5.625"H
Weight: Approx. 5 lbs.
Ceiling Cutout: 3.625"L x 3.625"W

Electrical

- Power Consumption: 39 watts max.
- Ambient temperature 100 °F. maximum.
- Integral electronic ballast.
- Through branch wiring capable.

Mounting
Universal mounting brackets included.
Contact factory for special ceiling conditions.

Options (Consult factory)
- Lenses: Page 2
Photometry: Page 3









All designs and scaled drawings shall remain the property of STARFIRE LIGHTING, INC., and may not be reproduced or transmitted without expressed written consent. STARFIRE LIGHTING, INC. reserves the right to make changes on approved designs to facilitate manufacturing methods to the extent that such changes do not compromise design integrity.

VW-3S-1-M6M

Job Name:

Fixture Type:

Lens Options

	Lenses		Cat. No.
<input type="checkbox"/>		Solite Spread Lens	SO
<input type="checkbox"/>		Frosted Solite Spread Lens	FS
<input type="checkbox"/>		Prismatic Spread Lens	PR
<input type="checkbox"/>		Frosted Prismatic Spread Lens	FP
<input type="checkbox"/>		Skytex Linear Spread Lens	SK
<input type="checkbox"/>		Frosted Skytex Linear Spread Lens	FK

For other lens options, consult factory.

VersaLux™ Series VW Micro 3" Square Wallwash, Square Trim with Lens

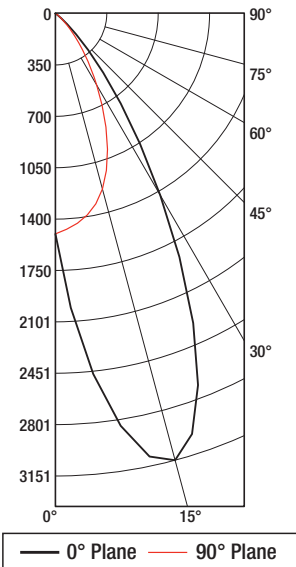

1 Lamp Photometrics 39 Watt MR16 Metal Halide, 25° Flood Skytex Lens

Photometry reports for other fixture configurations, consult factory

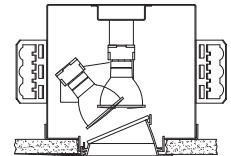

Total Luminaire Efficiency: 70.40%

Candela Distribution

	0	45	90	135	180
0	1501	1501	1501	1501	1501
15	3151	2572	1238	482	363
30	1428	1433	563	156	89
45	199	246	114	27	4
60	6	15	15	2	1
75	0	1	0	0	0
90	1	1	0	0	1
105	1	0	0	1	1
120	1	0	0	1	2
135	0	0	0	1	1
150	0	0	0	0	0
165	0	0	0	0	0
180	0	0	0	0	0

Zonal Lumen Summary

3.75	81
15	642
30	597
45	142
60	13
75	1
90	1

Utilization

RC	80				70				50			30			10			Flux
	70	50	30	10	70	50	30	10	50	30	10	50	30	10	50	30	10	
0	85	85	85	85	83	83	83	83	80	80	80	76	76	76	73	73	73	72
1	81	79	77	76	80	78	76	75	75	74	72	72	71	70	68	68	68	67
2	77	74	71	68	76	72	70	67	70	68	66	68	66	64	63	63	63	62
3	73	68	65	62	72	67	64	61	66	63	60	64	61	59	58	58	58	57
4	69	64	60	57	68	63	59	56	61	58	56	60	57	55	53	53	53	53
5	66	60	55	52	65	59	55	52	58	54	51	56	53	51	50	50	50	49
6	62	56	51	48	61	55	51	48	54	50	48	53	50	47	46	46	46	46
7	59	52	48	45	58	52	48	45	51	47	45	50	47	44	43	43	43	43
8	56	49	45	42	55	49	45	42	48	44	42	47	44	41	40	40	40	40
9	53	46	42	39	53	46	42	39	45	42	39	45	41	39	38	38	38	38
10	51	44	40	37	50	44	39	37	43	39	37	42	39	37	36	36	36	3